

**ULTRAFAST SOFT RECOVERY RECTIFIER DIODE**
**PRODUCT APPLICATIONS**

- Output Rectifiers for Switchmode Power Supply

**PRODUCT FEATURES**

- Ultrafast Recovery Times
- Soft Recovery Characteristics
- Popular TO-247 Package
- Low Forward Voltage
- Low Leakage Current

**PRODUCT BENEFITS**

- Low Losses
- Low Noise Switching
- Cooler Operation
- Higher Reliability Systems
- Increased System Power Density

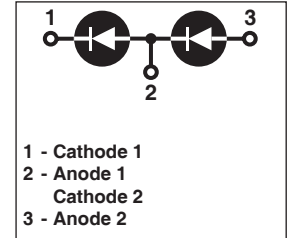
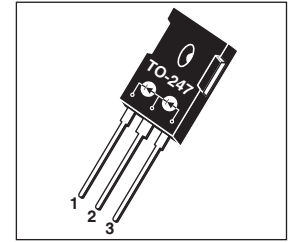
**MAXIMUM RATINGS**

 All Ratings Per Leg:  $T_C = 25^\circ\text{C}$  unless otherwise specified.

Symbol	Characteristic / Test Conditions	APT30D100BHB(G)	UNIT
$V_R$	Maximum D.C. Reverse Voltage	1000	Volts
$V_{RRM}$	Maximum Peak Repetitive Reverse Voltage		
$V_{RWM}$	Maximum Working Peak Reverse Voltage		
$I_{F(AV)}$	Maximum Average Forward Current ( $T_C = 105^\circ\text{C}$ , Duty Cycle = 0.5)	18	Amps
$I_{F(AV)}$	RMS Forward Current (Square wave, 50% duty)	27	
$I_{FSM}$	Non-Repetitive Forward Surge Current ( $T_J = 45^\circ\text{C}$ , 8.3ms)	210	
$T_J, T_{STG}$	Operating and Storage Temperature Range	-55 to 150	$^\circ\text{C}$
$T_L$	Lead Temperature for 10 Sec.	300	

**STATIC ELECTRICAL CHARACTERISTICS**

Symbol	Characteristic / Test Conditions	MIN	TYP	MAX	UNIT
$V_F$	Forward Voltage	$I_F = 30\text{A}$	1.9	2.3	Volts
		$I_F = 60\text{A}$	2.2		
		$I_F = 30\text{A}, T_J = 125^\circ\text{C}$	1.7		
$I_{RM}$	Maximum Reverse Leakage Current	$V_R = V_R$ Rated		250	$\mu\text{A}$
		$V_R = V_R$ Rated, $T_J = 125^\circ\text{C}$		500	
$C_T$	Junction Capacitance, $V_R = 200\text{V}$		32		pF

### DYNAMIC CHARACTERISTICS

APT30D100BHB(G)

Symbol	Characteristic	Test Conditions	MIN	TYP	MAX	UNIT
$t_{rr}$	Reverse Recovery Time	$I_F = 1A, di_F/dt = -100A/\mu s, V_R = 30V, T_J = 25^\circ C$	-	29		ns
$t_{rr}$	Reverse Recovery Time	$I_F = 30A, di_F/dt = -200A/\mu s, V_R = 667V, T_C = 25^\circ C$	-	290		
$Q_{rr}$	Reverse Recovery Charge		-	670		nC
$I_{RRM}$	Maximum Reverse Recovery Current		-	5	-	Amps
$t_{rr}$	Reverse Recovery Time	$I_F = 30A, di_F/dt = -200A/\mu s, V_R = 667V, T_C = 125^\circ C$	-	390		ns
$Q_{rr}$	Reverse Recovery Charge		-	2350		nC
$I_{RRM}$	Maximum Reverse Recovery Current		-	11	-	Amps
$t_{rr}$	Reverse Recovery Time	$I_F = 30A, di_F/dt = -1000A/\mu s, V_R = 667V, T_C = 125^\circ C$	-	160		ns
$Q_{rr}$	Reverse Recovery Charge		-	3500		nC
$I_{RRM}$	Maximum Reverse Recovery Current		-	38		Amps

### THERMAL AND MECHANICAL CHARACTERISTICS

Symbol	Characteristic / Test Conditions	MIN	TYP	MAX	UNIT
$R_{\theta JC}$	Junction-to-Case Thermal Resistance			1.8	$^\circ C/W$
$R_{\theta JA}$	Junction-to-Ambient Thermal Resistance			40	
$W_T$	Package Weight		0.22		oz
			5.9		g
Torque	Maximum Mounting Torque			10	lb•in
				1.1	N•m

APT Reserves the right to change, without notice, the specifications and information contained herein.

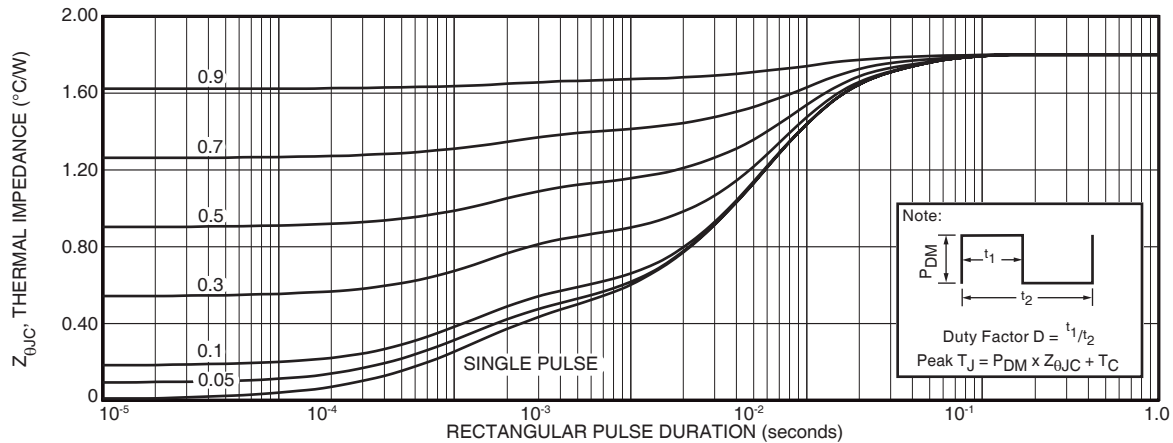

FIGURE 1a. MAXIMUM EFFECTIVE TRANSIENT THERMAL IMPEDANCE, JUNCTION-TO-CASE vs. PULSE DURATION

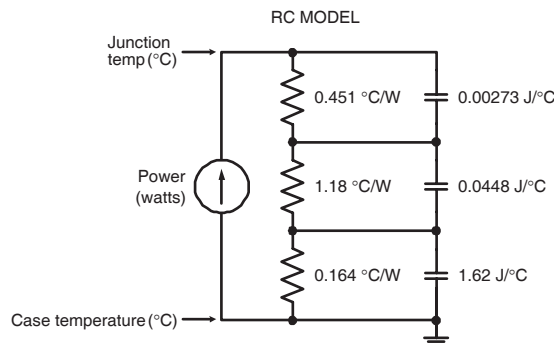

FIGURE 1b. TRANSIENT THERMAL IMPEDANCE MODEL

# TYPICAL PERFORMANCE CURVES

APT30D100BHB(G)

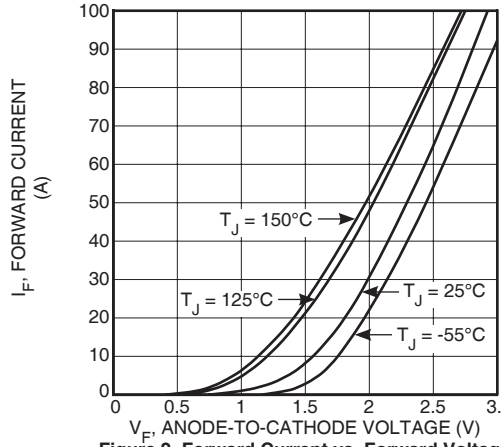

Figure 2. Forward Current vs. Forward Voltage

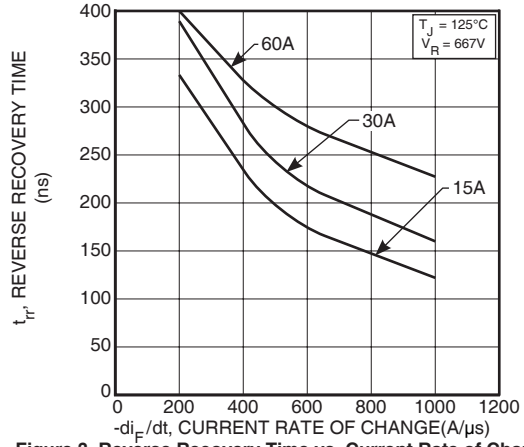

Figure 3. Reverse Recovery Time vs. Current Rate of Change

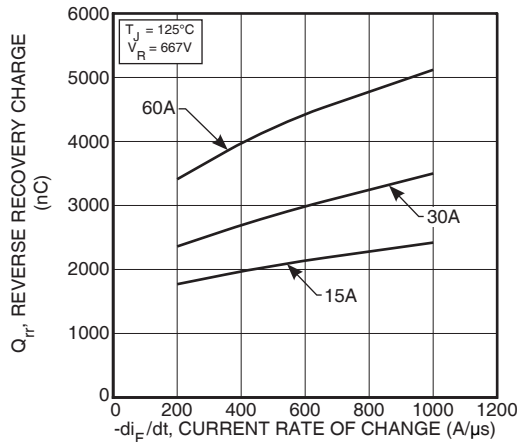

Figure 4. Reverse Recovery Charge vs. Current Rate of Change

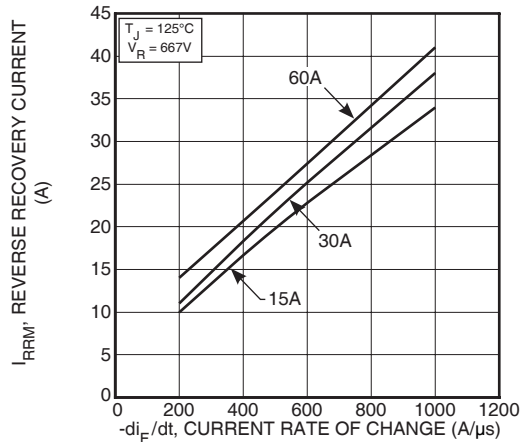

Figure 5. Reverse Recovery Current vs. Current Rate of Change

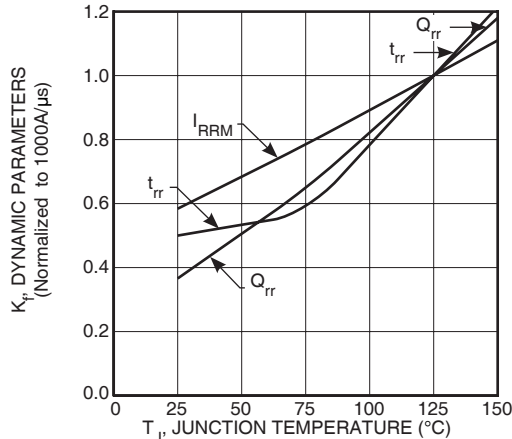

Figure 6. Dynamic Parameters vs. Junction Temperature

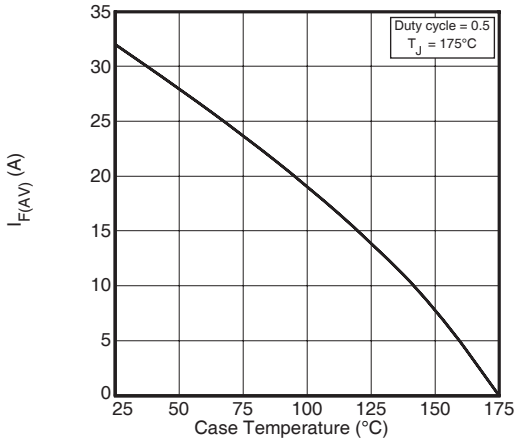

Figure 7. Maximum Average Forward Current vs. Case Temperature

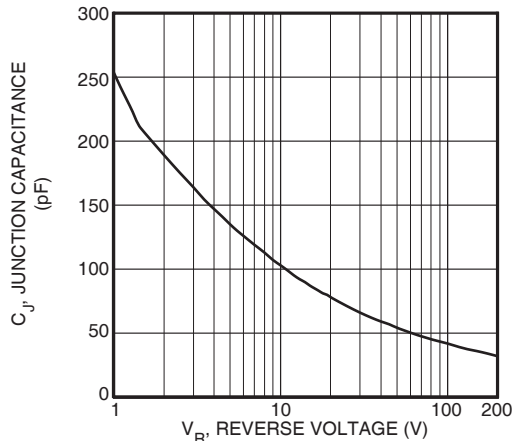

Figure 8. Junction Capacitance vs. Reverse Voltage

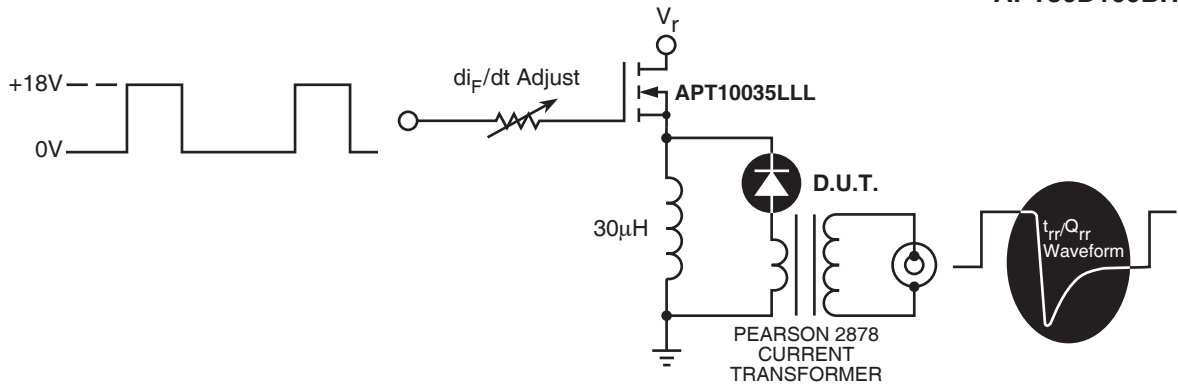

Figure 9. Diode Test Circuit

- 1  $I_F$  - Forward Conduction Current
- 2  $di_F/dt$  - Rate of Diode Current Change Through Zero Crossing.
- 3  $I_{RRM}$  - Maximum Reverse Recovery Current.
- 4  $t_{rr}$  - Reverse Recovery Time, measured from zero crossing where diode current goes from positive to negative, to the point at which the straight line through  $I_{RRM}$  and  $0.25 \cdot I_{RRM}$  passes through zero.
- 5  $Q_{rr}$  - Area Under the Curve Defined by  $I_{RRM}$  and  $t_{rr}$ .

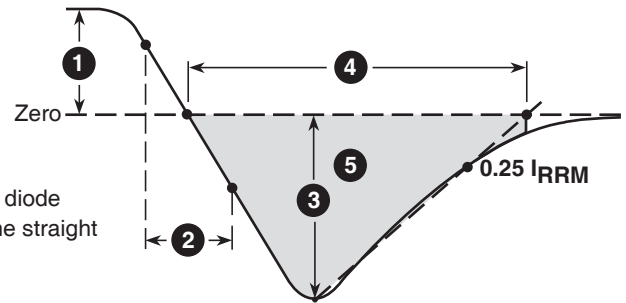
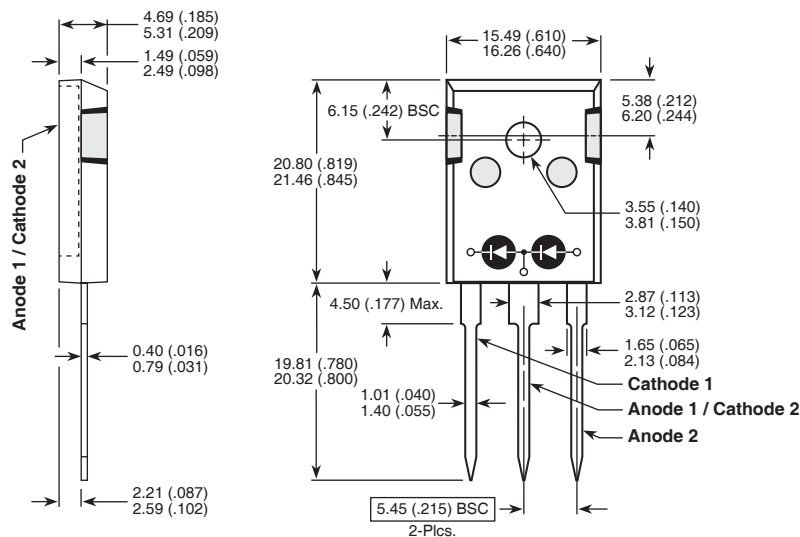

Figure 10, Diode Reverse Recovery Waveform and Definitions

### TO-247 Package Outline

(e1) SAC: Tin, Silver, Copper



Dimensions in Millimeters and (Inches)